

KEY FEATURES

- Open Frame Medical Switching Power Supply
- Remote ON/OFF Function
- 240 Watt with Free Air Convection
- 500 Watt with 30CFM FAN
- Built-in 12V/0.3A Auxiliary Output
- Standby 5V@1A with Fan, @0.4A without Fan
- High Efficiency up to 93%
- With P.F.C. Function >0.94
- Ultra Compact Size: 5.03 x 3.0 x 1.38 Inches
- 3-Year Product Warranty



ELECTRICAL SPECIFICATIONS

All specifications valid at normal input voltage, full load and +25°C after warm-up time unless otherwise stated.

Model No.	MQF5000-12S	MQF5000-24S	MQF5000-48S		
Max Output Wattage (W)	500 W (30CFM FAN)				
Max Output Wattage (W)	230 W (115 VAC) / 240 W (230 VAC)				
Input	Voltage	90-264 VAC or 127-370 VDC			
	Frequency (Hz)	47-63 Hz			
	Current (Full load)	<6.3 A max. (115 VAC) / <3.15 A max. (230 VAC)			
	Inrush Current (<2ms) (Cold Start)	< 40 A max. (115 VAC) / < 80 A max. (230 VAC)			
	Leakage Current	< 0.1 mA max. (Input-Output)			
	Power Factor (at 230 VAC)	PF>0.94 at Full Load			
Output	Voltage (V.DC.)	12V	24V	48V	
	Voltage Accuracy	±2%			
	Voltage Adj. Range (V.DC)	11.52~12.48	23.04~24.96	46.08~49.44	
	Current (with 30CFM FAN) (A) max	41.5	20.8	10.41	
	Current (Free air Convection) (A) max	at 115 VAC	19.16	9.58	4.8
		at 230 VAC	20	10	5
	Line Regulation (115-264 VAC)	±0.5%			
	Load Regulation (10-100%) (typ.)	±1%			
	Minimum Load	3%			
	Maximum Capacitive Load	10,000µF	5,000µF	2,500µF	
	Ripple & Noise (typ.)	160mV	240mV	480mV	
	Efficiency (at 230 VAC)	90.5%	92%	93%	
Hold-up Time (at 115 VAC)	8 ms min.				
Protection	Over Power Protection	Auto recovery			
	Over Voltage Protection	Auto recovery			
	Over Temperature Protection	Auto recovery			
	Short Circuit Protection	Auto recovery			
Isolation	Input-Output (V.AC)	4000VAC or 5656VDC			
	Input-FG (V.AC)	2000V			
	Output-FG (V.AC)	1500V			
Environment	Operating Temperature	-30°C...+70°C (with derating)			
	Storage Temperature	-35°C...+85°C			
	Temperature Coefficient	±0.03%/°C (0~50°C)			
		±0.06%/°C (-30~0°C)			
	Humidity	95% RH			
	MTBF	>160,000 h @ 25°C (MIL-HDBK-217F)			
Vibration	10~500Hz, 2G 10min./1cycle, 60min. each along X, Y, Z axes.				

ELECTRICAL SPECIFICATIONS

All specifications valid at normal input voltage, full load and +25°C after warm-up time unless otherwise stated.

Model No.		MQF5000-12S	MQF5000-24S	MQF5000-48S
Physical	Dimension (L x W x H)	5.03 x 3.0 x 1.38 Inches (127.8 x 76.2 x 35.0 mm) Tolerance ±0.5 mm		
	Weight	480 g		
	Cooling Method	Free convection / 30 CFM FAN		
Safety	Approval	cUL / UL Standard: UL 60950-1, CAN/CSA C22.2 No. 60950-1-07 ANSI/AAMI ES60601-1 (2005 + C1:09 + A2:10), CAN/CSA-C22.2 No. 60601-1 (2008), 2 x MOPP		
EMC	Conducted and radiated EMI	EN55011 class B, Radiated Class A		
	ESD	EN61000-4-2 air ± 8kV , Contact ± 4Kv		
	Radiated Immunity	EN61000-4-3 10V/m		
	Fast Transient	EN61000-4-4 ± 2kV		
	Surge	EN61000-4-5 ±1kV		
	Conducted Immunity	EN61000-4-6 10Vrms		
	PFMF	EN61000-4-8 30A/m		
	Dips	EN61000-4-11 30% 10ms		
	Interruption	EN61000-4-11 >95% 5000ms		

NOTE

- Ripple & Noise are measured at 20MHz of bandwidth with ceramic 0.1uF & chemi-con KY 47uF parallel capacitor.

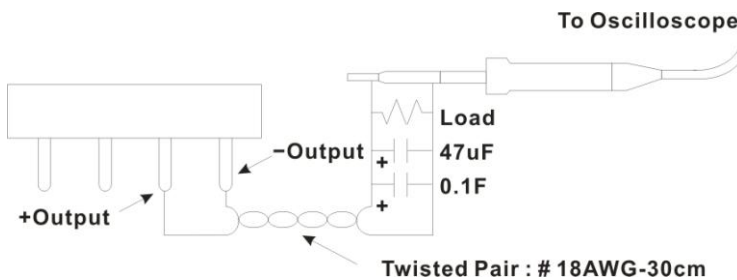

A 30cm twisted pair of no.18 AWG copper wire is connected to a 47uF and 0.1uF capacitor of proper polarity and voltage rating. The oscilloscope probe ground led should connect right to the ground ring of the probe and be as short as possible. The oscilloscope bandwidth should be at 20MHz and connected to AC ground.

- Hold-up Time measured at 90% Vout.
- Main Vout >3% Load, 12V (Aux) / 0.3A., 12V (Aux) need 0.1A Minimum Load, Auxiliary voltage output ground 10.2~13.3V
- Strongly recommend to conduct this test with DC Voltage. If customer wishes to test with AC Voltage, please disconnect all Y-Capacitors within power supply.

DERATING

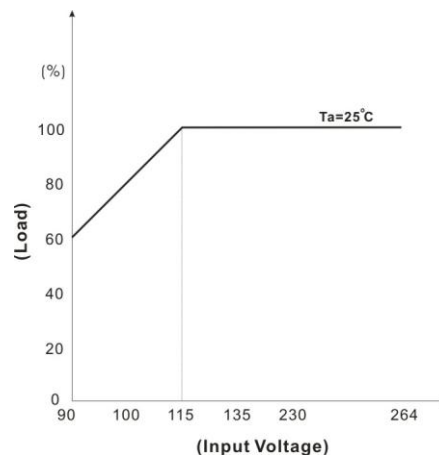
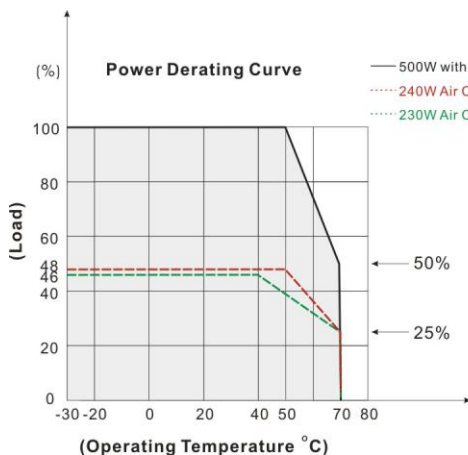

BLOCK DIAGRAM

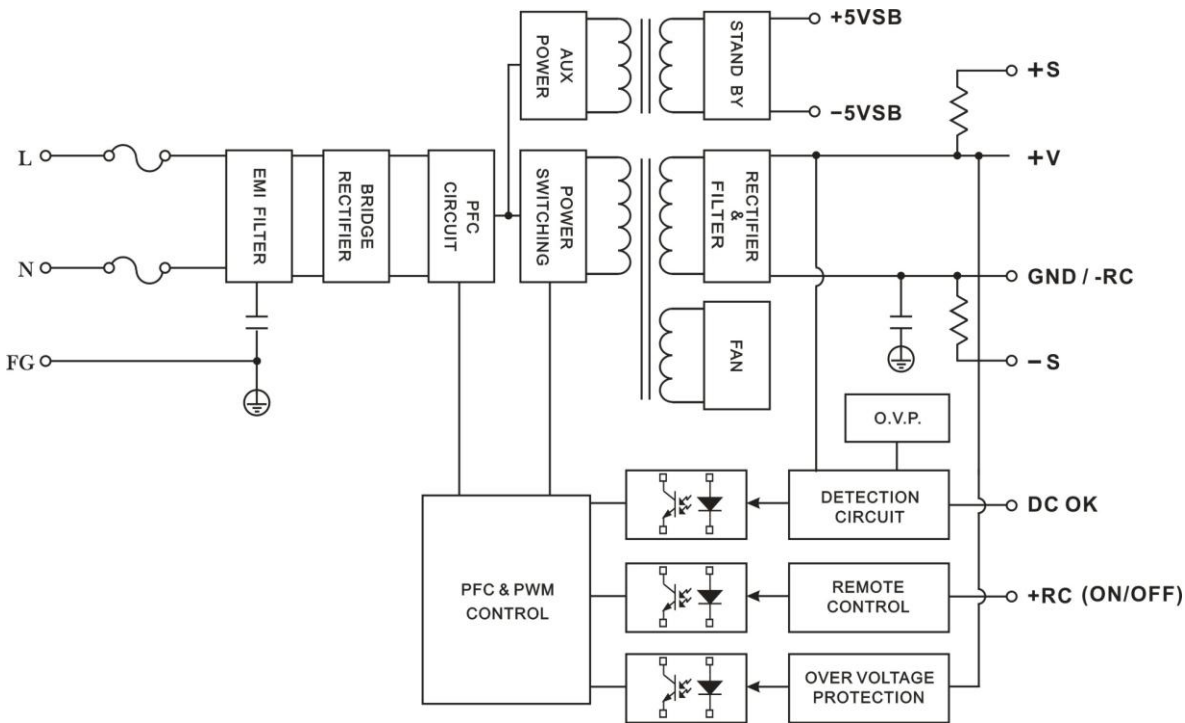

MECHANICAL DIMENSION (Top View)

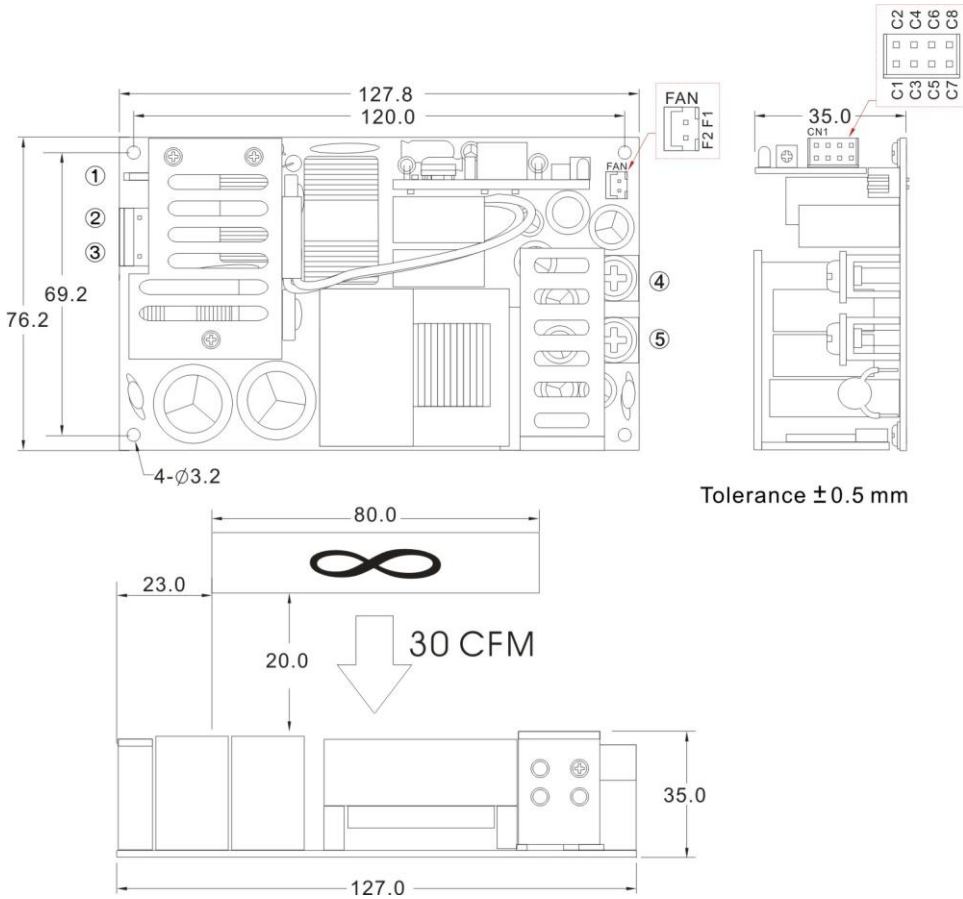

Tolerance ± 0.5 mm

PIN#	Single
1	FG
2	AC IN (N)
3	AC IN (L)
4	+DC OUT
5	-DC OUT

Connector Pin (FAN)	
PIN#	Single
F1	+12V
F2	GND

Connector Pin (CN1)	
PIN#	Single
C1	-5VSB
C2	+5VSB
C3	GND
C4	DC OK
C5	-RC
C6	+RC
C7	-S
C8	+S

FUNCTION DESCRIPITON of CN1

Pin No.	Function	Description
C1	-5VSB	This pin connects to the negative terminal(-V). Return for DC-OK and -RC signal output.
C2	+5VSB	Stand by voltage output ground 4.2~5.5V, referenced to pin C1(-5VSB). The maximum load current is 1A with Fan, 0.4A without Fan..
C3	GND	This pin connects to the negative terminal(-V). Return for DC-OK and -RC signal output.
C4	DC OK	DC-OK Signal is a DC output, referenced to pin C3(DC-OK GND).
C5	-RC	This pin connects to the negative terminal(-V). Return for DC-OK and -RC signal output.
C6	+RC	Turns the output on and off by electrical or dry contact between pin C5 (-RC), Short: Power OFF, Open: Power ON.
C7	-S	Negative sensing. The -S signal should be connected to the negative terminal of the load. The -S and +S leads should be twisted in pair to minimize noise pick-up effect.
C8	+S	Positive sensing. The +S signal should be connected to the positive terminal of the load. The +S and -S leads should be twisted in pair to minimize noise pick-up effect.

FUNCTION MANUAL & APPLICATION NOTE

1. DC-OK Signal

Between DC-OK and GND	Output Status
3.7~6V	ON
0~1V	OFF

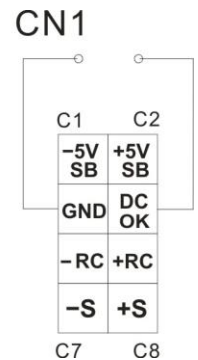
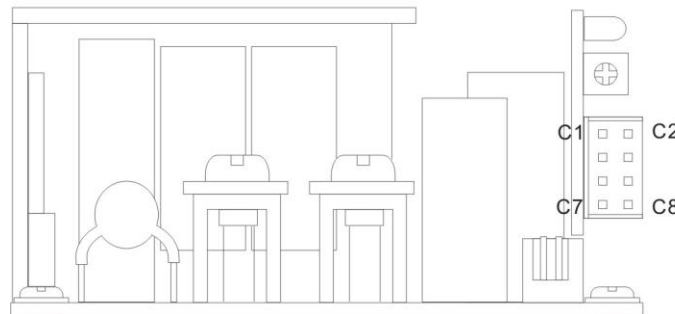

2. Remote Control

It can be turned ON/OFF by using the "Remote Control" function.

Between +RC and -RC	Output Status
SW ON (Short)	OFF
SW OFF (Open)	ON

