

KEY FEATURES

- Open Frame Switching Power Supply
- Remote ON/OFF Function
- 240 Watt with Free Air Convection
- 500 Watt with 30CFM FAN
- Built-in 12V/0.3A Auxiliary Output
- Standby 5V@1A with Fan, @0.6A without Fan
- High Efficiency up to 92%
- With P.F.C. Function >0.95
- Ultra Compact Size: 5.0 x 3.0 x 1.28 Inches
- 3-Year Product Warranty

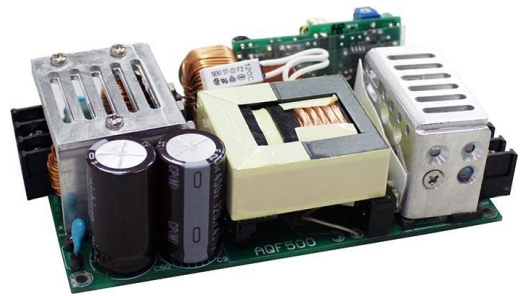

ELECTRICAL SPECIFICATIONS

All specifications valid at normal input voltage, full load and +25°C after warm-up time unless otherwise stated.

Model No.	DPO500-12S		DPO500-24S	DPO500-48S	
Max Output Wattage (W)	500 W (30CFM FAN)				
Max Output Wattage (W)	230 W (115 VAC) / 240 W (230 VAC)				
Input	Voltage	90-264 VAC or 120-370 VDC			
	Frequency (Hz)	47-63 Hz			
	Current (Full load)	<6.0 A max. (115 VAC) / <3.0 A max. (230 VAC)			
	Inrush Current (<2ms) (Cold Start)	< 35 A max. (115 VAC) / < 70 A max. (230 VAC)			
	Leakage Current	< 0.5 mA max.			
	Power Factor	PF>0.95 at Full Load			
Output	Voltage (V.DC.)	12V	24V	48V	
	Voltage Accuracy	±2%			
	Voltage Adj. Range (V.DC)	11.52~12.48	23.04~24.96	46.08~49.44	
	Current (with 30CFM FAN) (A) max	41.5	20.8	10.41	
	Current (Free air Convection) (A) max	at 115 VAC	19.16	9.58	4.8
		at 230 VAC	20	10	5
	Line Regulation (115-264 VAC)	±1%			
	Load Regulation (10-100%) (typ.)	±1.2%	±1%		
	Minimum Load	3%			
	Maximum Capacitive Load	10,000µF	5,000µF	2,500µF	
	Ripple & Noise (typ.)	150mV	240mV	480mV	
	Efficiency (at 230 VAC)	88%	90%	92%	
Hold-up Time (at 115 VAC)	8 ms min.				
Protection	Over Power Protection	Auto recovery			
	Over Voltage Protection	Auto recovery			
	Overt Temperature Protection	Auto recovery			
	Short Circuit Protection	Auto recovery			
Isolation	Input-Output (V.AC)	3000V			
	Input-FG (V.AC)	1500V			
	Output-FG (V.AC)	500V			
Environment	Operating Temperature	-40°C...+70°C (with derating)			
	Storage Temperature	-40°C...+85°C			
	Temperature Coefficient	±0.03%/°C (0~50°C)			
		±0.06%/°C (-40~0°C)			
	Humidity	95% RH			
	MTBF	>160,000 h @ 25°C (MIL-HDBK-217F, Notice 1)			
Vibration	10~500Hz, 2G 10min./1cycle, 60min. each along X, Y, Z axes.				

ELECTRICAL SPECIFICATIONS

All specifications valid at normal input voltage, full load and +25°C after warm-up time unless otherwise stated.

Model No.		DPO500-12S	DPO500-24S	DPO500-48S
Physical	Dimension (L x W x H)	5.0 x 3.0 x 1.28 Inches (127.0 x 76.2 x 32.5 mm) Tolerance ± 0.5 mm		
	Weight	460 g		
	Cooling Method	Free convection / 30 CFM FAN		
Safety	Agency Approvals	CE, UL60950-1, CB		
EMC	EMI (Conducted & Radiated Emission)	EN 55022 class B, Radiated Class A		
	EMS (Noise Immunity)	EN 55024		
	Surge	1KV L-N, 2KV L N-FG		

NOTE

1. Ripple & Noise are measured at 20MHz of bandwidth with 0.1uF & 47uF parallel capacitor.
2. It's recommended to add Varistor 14S471K at L / N input side in parallel.
3. Hold-up Time measured at 90% Vout.
4. Main Vout >3% Load, 12V (Aux) / 0.3A.

BLOCK DIAGRAM

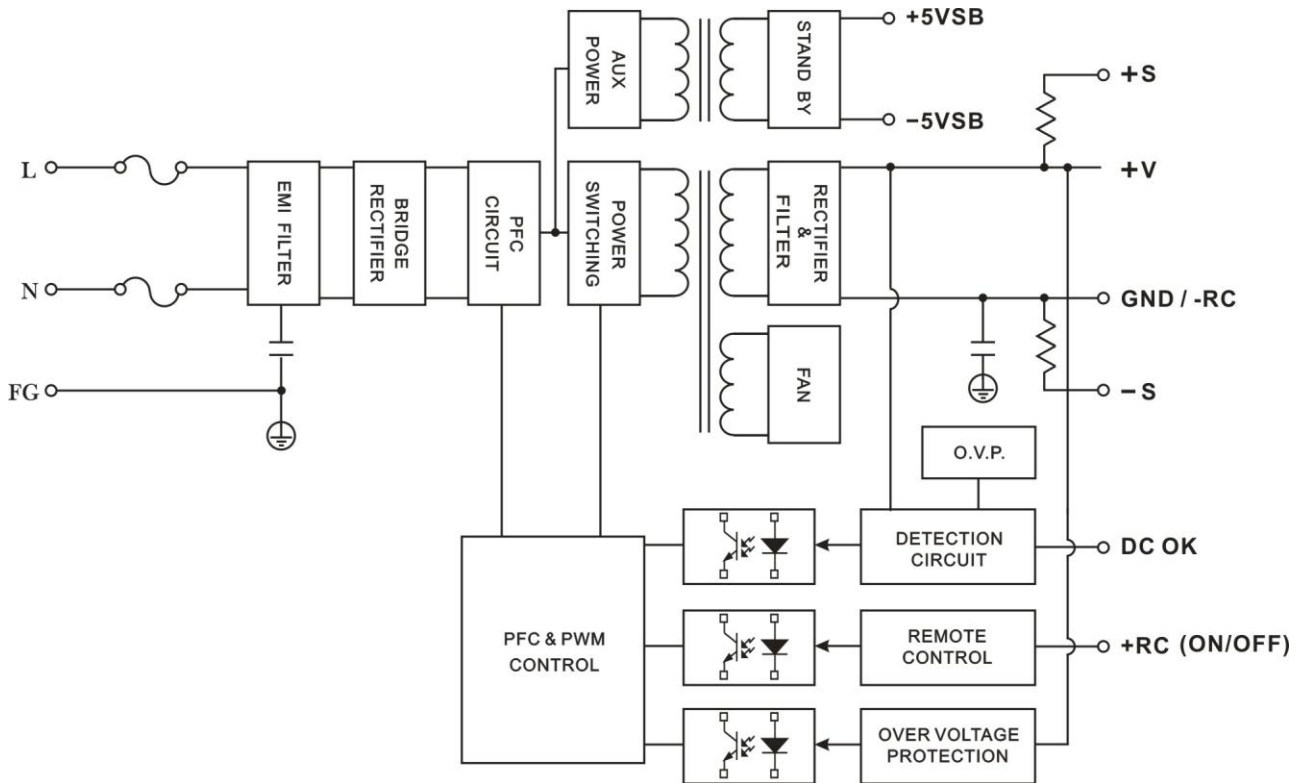

DERATING

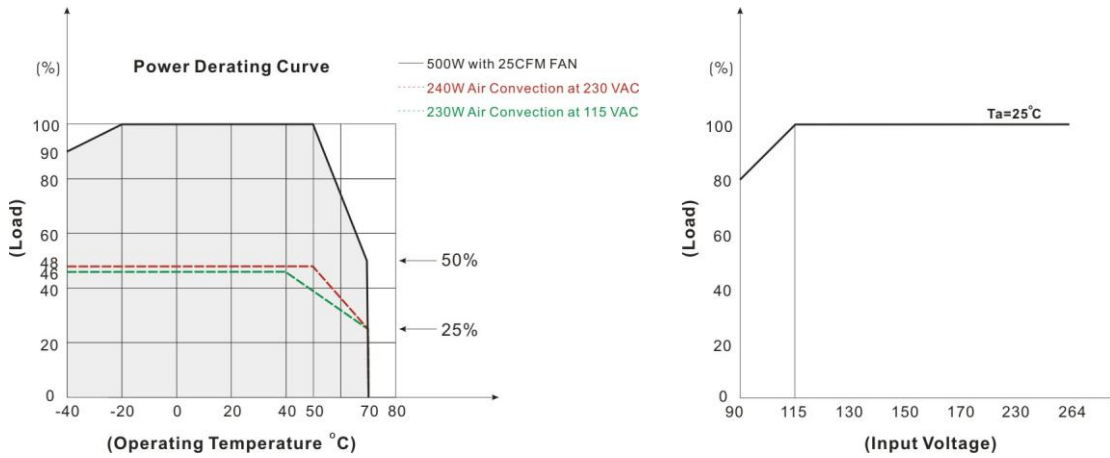

MECHANICAL DIMENSION (Top View)

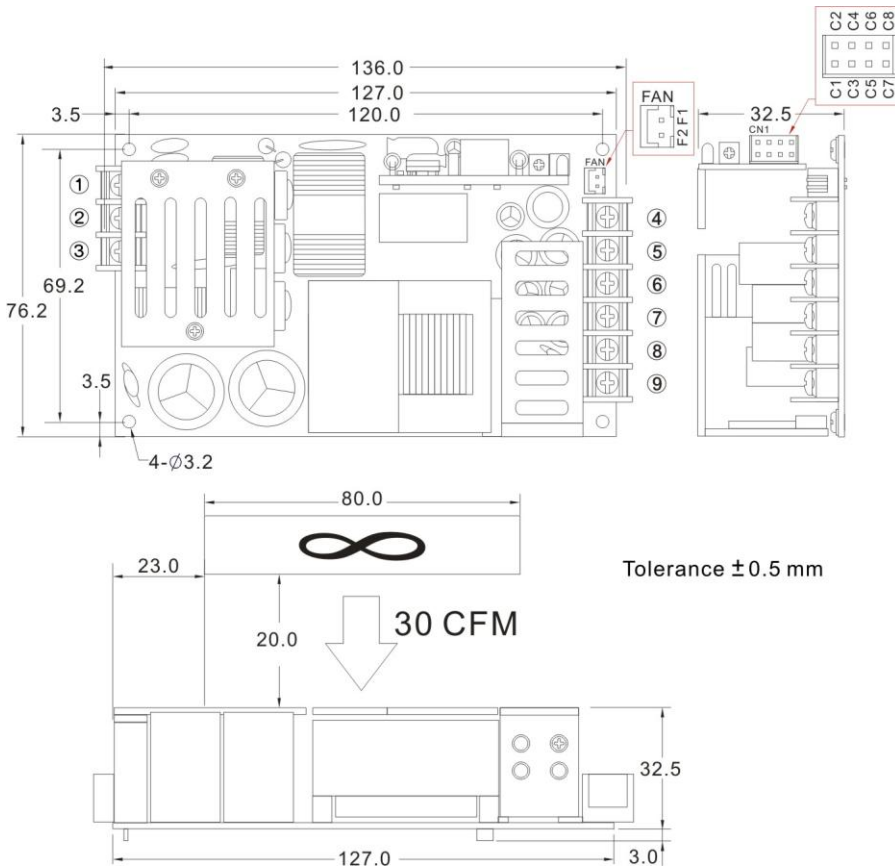

PIN#	Single
1	FG
2	AC IN (N)
3	AC IN (L)
4~6	+DC OUT
7~9	-DC OUT

Connector Pin (FAN)	
PIN#	Single
F1	+12V
F2	GND

Connector Pin (CN1)	
PIN#	Single
C1	-5VSB
C2	+5VSB
C3	GND
C4	DC OK
C5	-RC
C6	+RC
C7	-S
C8	+S

FUNCTION DESCRIPTION of CN1

Pin No.	Function	Description
C1	-5VSB	This pin connects to the negative terminal(-V). Return for DC-OK and -RC signal output.
C2	+5VSB	Stand by voltage output ground 3.7~6V, referenced to pin C8(+5VSB). The maximum load current is 0.6A.
C3	GND	This pin connects to the negative terminal(-V). Return for DC-OK and -RC signal output.
C4	DC OK	DC-OK Signal is a DC output, referenced to pin C6(DC-OK GND).
C5	-RC	This pin connects to the negative terminal(-V). Return for DC-OK and -RC signal output.
C6	+RC	Turns the output on and off by electrical or dry contact between pin C4 (-RC), Short: Power OFF, Open: Power ON.
C7	-S	Negative sensing. The -S signal should be connected to the negative terminal of the load. The -S and +S leads should be twisted in pair to minimize noise pick-up effect. The maximum line drop compensation is 0.3V.
C8	+S	Positive sensing. The +S signal should be connected to the negative terminal of the load. The +S and -S leads should be twisted in pair to minimize noise pick-up effect. The maximum line drop compensation is 0.3V.

FUNCTION MANUAL & APPLICATION NOTE

1. DC-OK Signal

Between DC-OK and GND	Output Status
3.7~6V	ON
0~1V	OFF

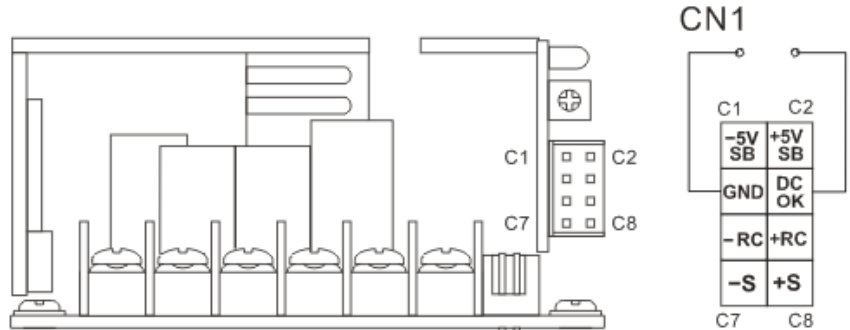

2. Remote Control

It can be turned ON/OFF by using the "Remote Control" function.

Between +RC and -RC	Output Status
SW ON (Short)	OFF
SW OFF (Open)	ON

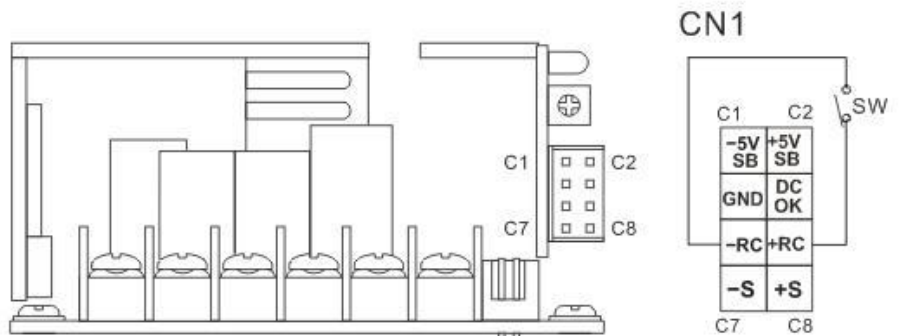

EFFICIENCY VERSUS LOAD

DPO500-12S

VIN VS Efficiency

Input Voltage (V)	90	115	180	230	264
Efficiency (%)	85.78	86.58	89.21	90.01	90.34

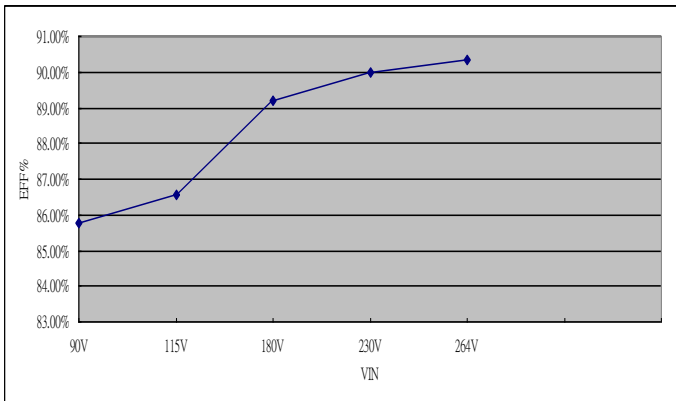

LOAD VS Efficiency

Load (%)	10	20	30	40	50
115V (%)	86.67	89.20	89.80	90.06	89.87
230V (%)	88.19	90.82	91.00	91.71	91.86
Load (%)	60	70	80	90	100
115V (%)	89.30	88.77	88.18	87.27	86.58
230V (%)	91.77	91.40	90.79	90.44	90.01

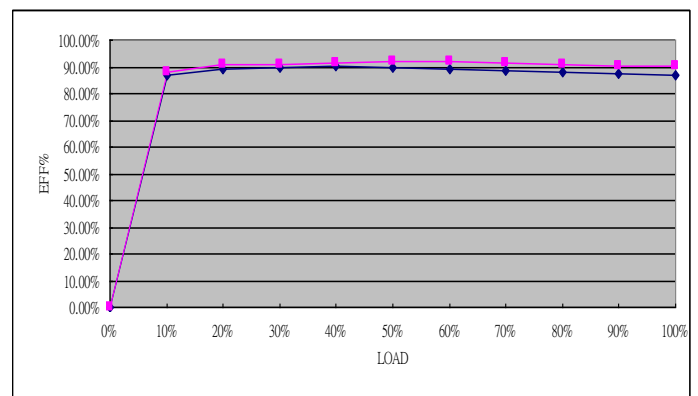

DPO500-24S

VIN VS Efficiency

Input Voltage (V)	90	115	180	230	264
Efficiency (%)	87.99	88.84	91.29	92.13	92.48

LOAD VS Efficiency

Load (%)	10	20	30	40	50
115V (%)	86.38	90.14	91.42	91.48	91.52
230V (%)	87.90	91.79	93.12	93.40	93.58
Load (%)	60	70	80	90	100
115V (%)	91.12	90.61	90.20	89.35	88.84
230V (%)	93.39	93.27	92.72	92.47	92.13

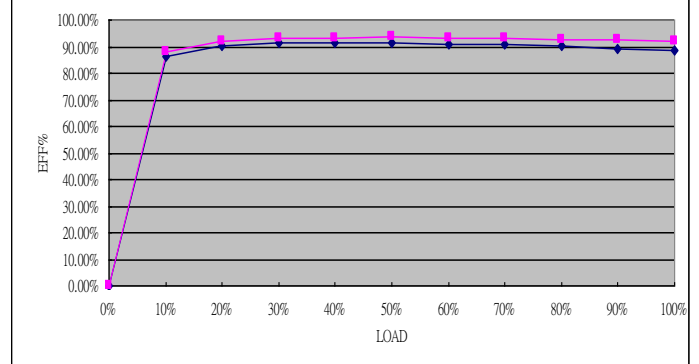
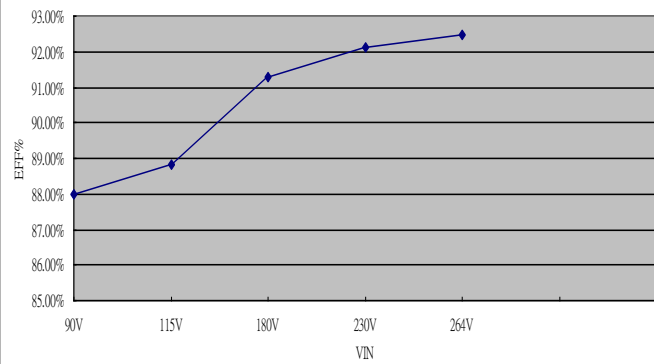

EFFICIENCY VERSUS LOAD

DPO500-48S

VIN VS Efficiency

Input Voltage (V)	90	115	180	230	264
Efficiency (%)	87.36	89.18	92.88	93.89	94.33

LOAD VS Efficiency

Load (%)	10	20	30	40	50
115V (%)	86.60	90.27	91.54	91.83	91.84
230V (%)	89.45	93.31	94.10	94.45	94.66
Load (%)	60	70	80	90	100
115V (%)	91.67	91.33	90.72	90.14	89.47
230V (%)	94.65	94.47	94.22	94.29	93.96

